

Operating Instructions for the DVD/CD Player

Model No. **DVD-LS80**
DVD-LS80
DVD-LS80

Unless otherwise indicated, illustrations in these operating instructions are of DVD-LS80.

P

PC

Accessories



Use numbers indicated in parentheses when asking for replacement parts.

(Product numbers correct as of December 2006. These may be subject to change.)

*(For U.S.A.) To order accessories, refer to "Accessory Purchases" on page 33.
(For Canada) To order accessories, call the dealer from whom you have made your purchase.*

- 1 Audio/video cable** (K2KA6CB00003)
- 1 AC adaptor**
For U.S.A. (RFEA216W or RFEA217P)
For Canada (RFEA216W)
- 1 AC power supply cord** (K2CB2CB00020)
For use with this unit only. Do not use it with other equipment.
Also, do not use cords for other equipment with this unit.
- 1 Car DC Adaptor** (RFEC203M-Y)
- 1 Headrest Mounting Bracket** (RXQ1405A)
only included with **DVD-LS82** **DVD-LS850**
- 1 Rechargeable battery pack**

	Included	Optional
DVD-LS80	CGR-H711	CGR-H701 CGR-H712
DVD-LS850		
DVD-LS82	CGR-H712	

- Depending on the battery pack, playback time may differ. (→ page 9, Approximate recharging and play times)
- **DVD-LS80** **DVD-LS850** CGR-H711 is not available as option. When purchasing a replacement, request one of the optional batteries listed above.

CAUTION!

THIS PRODUCT UTILIZES A LASER.
USE OF CONTROLS OR ADJUSTMENTS
OTHER THAN THOSE SPECIFIED HEREIN
MAY RESULT IN HAZARDOUS RADIATION
EXPOSURE.
DO NOT OPEN COVERS AND DO NOT
REPAIR YOURSELF. REFER SERVICING TO
QUALIFIED PERSONNEL.

Table of contents

Accessories	3
IMPORTANT SAFETY INSTRUCTIONS ..	4
Discs that can be played	6
Tips for making data discs	7

Preparations

1 Attaching the battery	8
2 Recharging the battery	8
Approximate recharging and play times ..	9
Checking the remaining battery charge ..	9
3 Adjusting the LCD angle	9

Playing discs	10
Useful functions	12

Selecting how to show 4:3 aspect pictures on the LCD	12
Selecting the picture quality on the LCD ..	12
Repeat play	12
To repeat a specified section (A-B Repeat) ..	12
Reviewing titles/programs to play (Advanced Disc Review)	13
Changing play speed	13
Enjoying virtual surround (Advanced Surround) ..	13
Changing soundtracks	14
Changing subtitles	14
Angle select/Still picture rotation	14
Displaying current playback condition (Quick OSD)	15

Enjoying higher quality

audio and video	15
Enjoying heavy bass with the speakers (H.Bass) ..	15
Providing the suitable picture quality for enjoying movies (Cinema1/Cinema2) ..	15
Reducing noise in pictures (Depth Enhancer/MPEG DNR)	15

Playing audio (WMA/MP3), picture (JPEG) and video (MPEG4/DivX) discs	16
Playing items in order (Playback Menu) ..	16
Playing from the selected item (Navigation Menu) ..	16

Playing HighMAT™ discs	17
-------------------------------------	----

Playing programs/playlists	17
---	----

Playing CD using menus	17
-------------------------------------	----

Enjoying in a car	18
--------------------------------	----

Enjoying video in the back seat with the Headrest Mounting Bracket	18
Connecting the included Car DC Adaptor ..	20

About DivX VOD content	21
-------------------------------------	----

Using On-Screen Menus	22
------------------------------------	----

Changing the player settings	24
---	----

Using this unit with other equipment ..	26
--	----

Frequently asked questions	27
---	----

Maintenance	27
--------------------------	----

Specifications	28
-----------------------------	----

Troubleshooting guide	29
------------------------------------	----

Limited Warranty (ONLY FOR U.S.A.) ..	32
--	----

Product Service	33
------------------------------	----

Limited Warranty (ONLY FOR CANADA) ..	34
--	----

Index	Back cover
--------------------	------------

WARNING:

The driver must not operate this unit while the vehicle is moving.
Do not operate this unit where it can be viewed by the driver.
Driver operation or viewing of this unit while the vehicle is moving will cause distraction which may result in serious accident and personal injury or property damage.

CAUTION!

DO NOT INSTALL OR PLACE THIS UNIT IN A BOOKCASE, BUILT-IN CABINET OR IN ANOTHER CONFINED SPACE.
ENSURE THE UNIT IS WELL VENTILATED. TO PREVENT RISK OF ELECTRIC SHOCK OR FIRE HAZARD DUE TO OVERHEATING, ENSURE THAT CURTAINS AND ANY OTHER MATERIALS DO NOT OBSTRUCT THE VENTILATION VENTS.

AC adaptor

This AC adaptor operates on AC between 100 V and 240 V.

But

- In the U.S.A. and Canada, the AC adaptor must be connected to a 120 V AC power supply only.
- When connecting to an AC supply outside of the U.S.A. or Canada, use a plug adaptor to suit the AC outlet configuration.
- When connecting to a supply of greater than AC 125 V, ensure the cord you use is suited to the voltage of the AC supply and the rated current of the AC adaptor.
- Contact an electrical parts distributor for assistance in selecting a suitable AC plug adaptor or AC cord set.

The socket outlet shall be installed near the equipment and easily accessible.
The mains plug of the power supply cord shall remain readily operable.
To completely disconnect this apparatus from the AC Mains, disconnect the power supply cord plug from AC receptacle.

Listening caution



Do not play your headphones or earphones at a high volume. Hearing experts advise against continuous extended play. If you experience a ringing in your ears, reduce volume or discontinue use. Do not use while operating a motorized vehicle. It may create a traffic hazard and is illegal in many areas.

You should use extreme caution or temporarily discontinue use in potentially hazardous situations. Even if your headphones or earphones are the open-air type designed to let you hear outside sounds, don't turn up the volume so high that you can't hear what's around you. Sound can be deceiving. Over time your hearing "comfort level" adapts to higher volumes of sound. So what sounds "normal" can actually be loud and harmful to your hearing.

Guard against this by setting your equipment at a safe level BEFORE your hearing adapts.

To establish a safe level:

- Start your volume control at a low setting.
- Slowly increase the sound until you can hear it comfortably and clearly, and without distortion.

Once you have established a comfortable sound level:

- Leave it there.

Do not rest the unit on your lap for a long time while using it. The unit can become hot and cause burns.

To prevent damage

Avoid the following:

- Spraying flammable insecticides near the unit.
- Pressing the LCD.
- Touching the lens and other parts of the laser pickup.

Do not use the unit in the following places:

- Sandy places such as beaches.
- On top of cushions, sofas, or hot equipment such as amplifiers.

Do not leave in an unventilated automobile or exposed to direct sunlight and high temperatures.

-If you see this symbol-





Information on Disposal in other Countries outside the European Union

This symbol is only valid in the European Union.

If you wish to discard this product, please contact your local authorities or dealer and ask for the correct method of disposal.

Discs that can be played



Commercial discs

Disc Logo	Indicated in these instructions by	Remarks
	DVD-V	High quality movie and music discs
	VCD	Music discs with video including SVCD (Conforming to IEC62107)
	CD	Music discs

■ Discs that cannot be played

Blu-ray, HD DVD, DVD-Audio, Version 1.0 of DVD-RW, DVD-ROM, CD-ROM, CDV, CD-G, SACD and Photo CD, DVD-RAM that cannot be removed from their cartridges, 2.6-GB and 5.2-GB DVD-RAM, PAL discs and “Chaoji VCD” available on the market including CVD, DVCD and SVCD that do not conform to IEC62107.

Recorded disc (Yes: Available No: Not available)

Disc Logo	Recorded on a DVD recorder, etc.		Recorded on a personal computer, etc.					Necessity of finalize ^{#4}
	DVD-VR ^{#2}	DVD-V ^{#3}	WMA	MP3	JPEG	MPEG4	DivX	
	Yes	—	No	Yes	Yes	Yes	Yes	Not Necessary
	Yes	Yes	No	Yes	Yes	Yes	Yes	Necessary
	Yes	Yes	No	No	No	No	No	Necessary
+R/+RW —	No	(Yes)	No	No	No	No	No	Necessary
+R DL —	No	(Yes)	No	No	No	No	No	Necessary
CD-R/RW ^{#1} —	—	—	Yes	Yes	Yes	Yes	Yes	Necessary ^{#5}

• It may not be possible to play the above discs in all cases due to the type of discs, the condition of the recording, the recording method and how the files were created (→ page 7, Tips for making data discs).

^{#1} This unit can play CD-R/RW recorded with CD-DA or Video CD format. (**WMA MP3 JPEG** This unit also plays HighMAT™ discs.)

^{#2} Discs recorded on DVD recorders, DVD video cameras, etc. using Version 1.1 of the Video Recording Format (a unified video recording standard).

For DVD-R DL: Discs recorded on DVD recorders or DVD video cameras using Version 1.2 of the Video Recording Format (a unified video recording standard).

^{#3} Discs recorded on DVD recorders or DVD video cameras using DVD-Video Format. For +R/+RW and +R DL: Discs recorded using a format different from DVD-Video Format, therefore some functions cannot be used.

^{#4} A process that allows play on compatible equipment. To play a disc that is displayed as “Necessary” on this unit, the disc must first be finalized on the device it was recorded on.

^{#5} Closing the session will also work.

Note about using a DualDisc

- The digital audio content side of a DualDisc does not meet the technical specifications of the Compact Disc Digital Audio (CD-DA) format so play may not be possible.
- Do not use a DualDisc in this unit as it may not be possible to insert it correctly and it may get scratched or scraped.

Tips for making data discs

Format	Disc	Extension	Reference
WMA	CD-R/RW	“.WMA” “.wma”	•

- If groups were created away from the root like “002 group” in the illustration below, the eighth one and onwards is displayed on the same vertical line in the menu screen.
- There may be differences in the display order on the menu screen and computer screen.
- This unit cannot play files recorded using packet writing.

Naming folders and files on data discs

(Files are treated as contents and folders are treated as groups on this unit.)

At the time of recording, prefix folder and file names. This should be with numbers that have an equal number of digits, and should be done in the order you want to play them (this may not work at times).

DVD-RAM

- Discs must conform to UDF 2.0.

DVD-R/RW

- Discs must conform to UDF bridge (UDF 1.02/ISO9660).
- This unit is not compatible with multi-session. Only the default session is played.

CD-R/RW

- Discs must conform to ISO9660 level 1 or 2 (except for extended formats).
- This unit is compatible with multi-session but if there are a lot of sessions it takes more time for play to start. Keep the number of sessions to a minimum to avoid this.

Preparations

① Attaching the battery (When the unit is off)

The illustrations shown are of CGR-H711; however the steps for CGR-H712 (included with DVD-LS82) or CGR-H701 (optional) are the same.

Bottom side of this unit

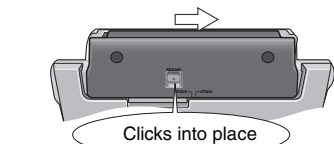
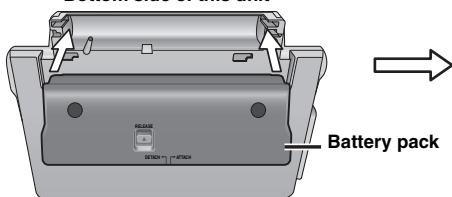

Check to make sure it is securely fastened.

Detaching

- Turn the unit off before detaching the battery pack.

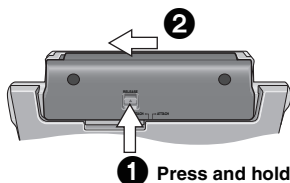

① Press and hold

When not using for long periods of time

- Remove the battery pack (→ left).
(Even when the unit is turned off, there is a small amount of voltage running through the unit, and this may result in a malfunction.)
- Recharge the battery for re-use.

② Recharging the battery

The battery is not charged at the time of purchase. Charge before initial use.

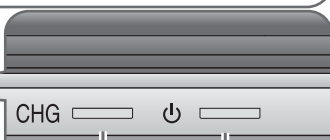
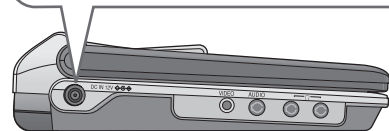
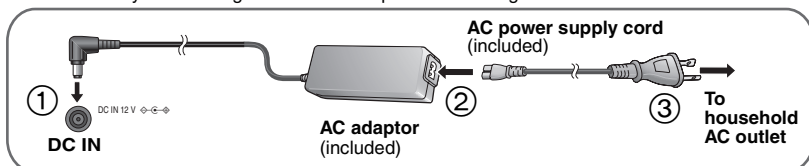

- You can also use this unit without charging while connecting the AC adaptor and the AC power supply cord.
- You can also use this unit without charging while connecting Car DC Adaptor (→ page 20, Enjoying in a car).

To conserve power

This unit consumes 0.4 W of power even when turned off. When the unit is not going to be used for a long time, disconnect the AC power supply cord from the household AC outlet.

CHG [Started] [Finished]

[⏻] goes out → lights*
[CHG] lights → goes out
* Only when recharged with the unit off.

Recharging time :

→ page 9, Approximate recharging and play times

When finished, disconnect the AC adaptor and the AC power supply cord.

Playing discs

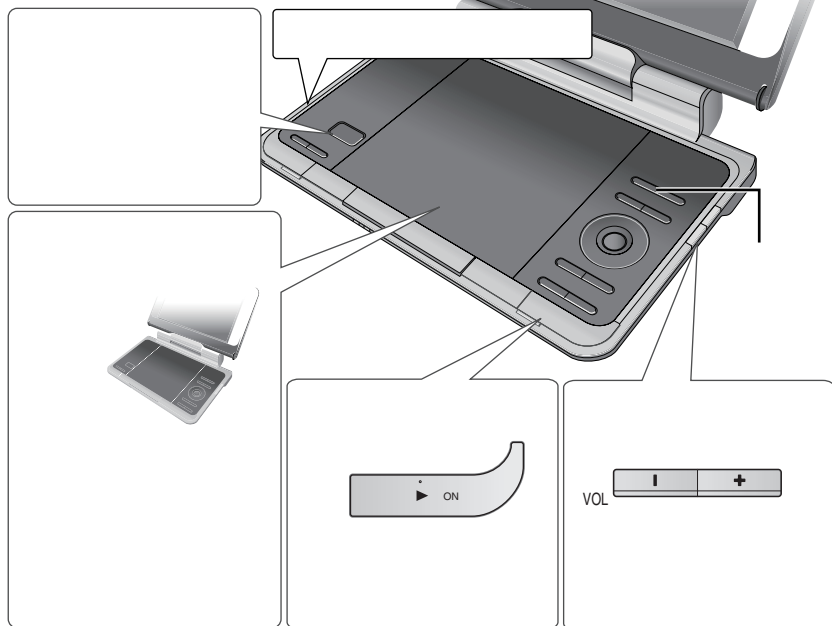









- To play audio (**MP3**), picture (**JPEG**) or video (**MPEG4 DivX**) on DVD-RAM with recorded titles (**DVD-VR**), select "Play as Data Disc" (→ page 23, Other Menu).
- While stopped, the unit automatically turns off once 15 minutes (after approximately 5 minutes when using the battery pack) have elapsed.
- Total title number may not be displayed properly on +R/+RW.
- If you are experiencing problems, refer to troubleshooting guide (→ page 29).

Note

- DISCS CONTINUE TO ROTATE WHILE MENUS ARE DISPLAYED. Press [**■**, **-OFF**] when you finish to preserve the unit's motor.

Operations

	Turn unit on/play	When the unit is off: Press and hold and the power comes on and play begins. When the unit is on: Press and play begins.
	Pause	Press [▶, ON] to restart play.
	Stop	The position is memorized when "Press PLAY to resume play" appears on the screen. • Press [▶, ON] to resume. (Resume play) Opening the disc lid, or pressing [■, -OFF] while "Press PLAY to resume play" appears on the screen cancels the memorized position.
	Turn unit off	Press and hold until "OFF" is displayed.
	Skip	Press [◀◀, ▶▶]. DVD-VR Can also skip to the markers.
	Search	Press and hold [◀◀, ▶▶] (up to 5 steps).
	Slow play	Press and hold [◀◀, ▶▶] (up to 5 steps) while paused. Press [▶, ON] to return to normal play. VCD [▶▶] only • MPEG4 DivX : Does not work.
	Top menu	DVD-V
	Playing programs	DVD-VR (→ page 17) WMA MP3 JPEG MPEG4 DivX (→ page 16)
	Menu	DVD-V
	Playing playlists	DVD-VR (→ page 17)
	Navigation menu	WMA MP3 JPEG MPEG4 DivX (→ page 16)
	Return	Returns to the previous screen. VCD (with playback control) Returns to the menu.
	Menu operation	Press [▲ ▼ ◀ ▶] to select an item and press [ENTER] to confirm.
	Number Select	VCD (with playback control) ① While the disc menu is displayed, press [DISPLAY] to display On-Screen Menus. ② Press [▲ ▼] to select "Number Select". ③ Press [▶] then [▲ ▼] to enter number. • Press and hold [▲ ▼] to alter faster. ④ Press [ENTER].
	Frame-by-frame	DVD-VR DVD-V VCD While paused, press [◀ ▶]. VCD [▶] only
	Group skip	WMA MP3 JPEG MPEG4 DivX Press [▲ ▼]. • Does not work while paused.

Useful functions

Selecting how to show 4:3 aspect pictures on the LCD



LCD-SIZE

MONITOR NORMAL: Normal
MONITOR FULL: Stretched horizontally
MONITOR OFF: No picture

- If you are not using the LCD on this unit, select "MONITOR OFF" to conserve power. (The indicator flashes)

Press to change. • The LCD turns off automatically if you close it.

Selecting the picture quality on the LCD



BRIGHT-LCD

DAYLIGHT: Displays the picture a bit brighter.
MOONLIGHT: Displays the picture a bit darker.
USER MODE: → below

Press to change.

■ When selecting "USER MODE"

Press [] to select the item, and [] to change the setting.

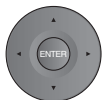

- BRIGHT:** Adjusts the brightness of the picture (-5 to 5)
COLOR: Adjusts the shade of the picture's color (-5 to 5)
- To exit the screen: Press [RETURN].

Repeat play (Only when the elapsed play time can be displayed.)

JPEG: you can use even if there is no elapsed time display.)



REPEAT

Press several times to select the content to be repeated.

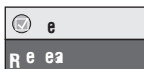

To repeat a specified section (A-B Repeat)

Only when the elapsed play time can be displayed.

Except **DVD-VR** (still picture part) **DivX** **JPEG** and **MPEG4**

1



DISPLAY

During play, press once.

2



- 1 Press [] to select "Other Settings".
- 2 Press [] then [] to select "Play Menu".
- 3 Press [] then [] to select "A-B Repeat".
- 4 Press [ENTER] at the starting and ending points.

- Press [ENTER] again to cancel.
- To exit the screen: Press [RETURN].



Reviewing titles/programs to play (Advanced Disc Review)

DVD-VR DVD-V (Except +R/+RW)

1 
Press once.

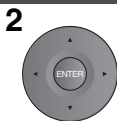

- 1 Press [▲▼] to select "Other Settings".
- 2 Press [▶] then [▲▼] to select "Play Menu".
- 3 Press [▶] then [▲▼] to select "Advanced Disc Review".
- 4 Press [ENTER].
Reviews each title/program.
- 5 Press [▶, ON] when you find a title/program to play.



- You can also review each 10 minutes. Select "Interval Mode" (→ page 24, "Advanced Disc Review" in "Disc" tab).
- This may not work depending on the play position.
- **DVD-VR** Does not work:
 - with still picture part.
 - when playing a playlist.
- To exit the screen: Press [RETURN].

Changing play speed DVD-VR DVD-V

1 
During play, press once.

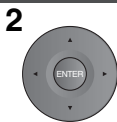

- 1 Press [▲▼] to select "Other Settings".
- 2 Press [▶] then [▲▼] to select "Play Speed".
- 3 Press [ENTER] and [▲▼] to select "Normal" or "×0.6" to "×1.4" (in 0.1 units).
- 4 Press [ENTER].

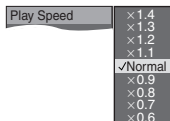

- Press [▶, ON] to return to normal play.
- After you change the speed
 - H.Bass (→ page 15), Advanced Surround (→ below) and Sound Enhancement (→ page 23, Audio Menu) do not work.
 - 96 kHz sampling frequency is converted to 48 kHz.
- This may not work depending on the disc's recording.
- To exit the screen: Press [RETURN].

Enjoying virtual surround (Advanced Surround)

Motion pictures with 2 or more channels

1 
Press once.

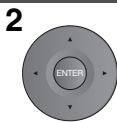

- 1 Press [▲▼] to select "Other Settings".
- 2 Press [▶] then [▲▼] to select "Audio Menu".
- 3 Press [▶] then [▲▼] to select "Advanced Surround".
- 4 Press [▶] then [▲▼] to select "SP 1 Natural", "SP 2 Enhanced", "HP 1 Natural" or "HP 2 Enhanced".
- 5 Press [ENTER].

A surround sound effect can be made using 2 speakers (on other equipment).

- When using headphones, press to select "HP 1 Natural" or "HP 2 Enhanced".
- When using discs recorded with surround sound, sound seems to come from speakers on either side of you.
- Optimum seating position is 3 to 4 times the distance between the front left and right speakers or the width of the television if using the television's speakers.
- This does not work when H.Bass (→ page 15) is on.
- Do not use in combination with surround effects on other equipment.
- To exit the screen: Press [RETURN].

Useful functions

Changing soundtracks *Motion pictures*

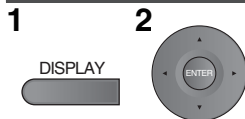

Press once.

- ① Press [**▲▼**] to select "Audio".
- ② Press [**▶**] then [**▲▼**] to select the soundtrack.
- ③ Press [**ENTER**].

DVD-VR **DivX**

"L", "R" or "L R" can be selected.

VCD

"L", "R", "L R" or "L + R" can be selected.

DVD-V (Karaoke discs)

① Press [**▲▼**] to select "Vocal".

② Press [**▶**] then [**▲▼**] to select "On" or "Off" for vocals.

Read the disc's instructions for details.

• **To exit the screen** : Press [**RETURN**].

Signal type/data

LPCM/**□□** Digital/DTS/MP3/MPEG: Signal type

kHz (Sampling frequency)/bit/ch (Number of channels)

Example: 3/2 .1ch

- 1: Low frequency effect
(not displayed if there is no signal)
- 0: No surround
- 1: Mono surround
- 2: Stereo surround (left/right)
- 1: Center
- 2: Front left+ Front right
- 3: Front left+ Front right+ Center

• **DivX** It may take some time for play to start if you change the audio on a DivX video disc.



Changing subtitles *Discs with subtitles*

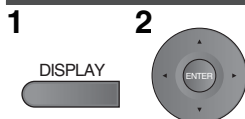

Press once.

DVD-VR **DVD-V** **VCD** **DivX**

① Press [**▲▼**] to select "Subtitle".

② Press [**▶**] then [**▲▼**] to select "Off" or "On" and the subtitle language.

③ Press [**ENTER**].

• On + R/+RW, a subtitle number may be shown for subtitles that are not displayed.

• **DVD-VR** (with subtitle on/off information)

– On or Off only can be selected.

– Subtitle on/off information cannot be recorded using Panasonic DVD Recorders.

• **To exit the screen**: Press [**RETURN**].

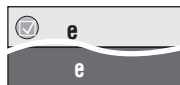

Angle select **DVD-V** with multiple angles / Still picture rotation **JPEG**

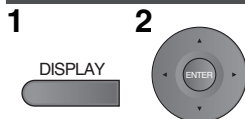

Press once.

① Press [**▲▼**] to select "Angle" or "Rotate Picture".

② Press [**▶**] then [**▲▼**] to select the angle or rotate the still picture.

③ Press [**ENTER**].

• **To exit the screen**: Press [**RETURN**].

e.g. **DVD-V**



Displaying current playback condition (Quick OSD)

■ Basics

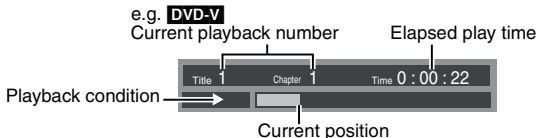

Press twice.

■ Details

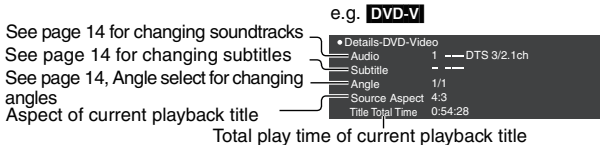

Press three times.

- **MPEG4 DivX** Video and audio information is not displayed during search.
- To exit the screen : Press [RETURN].

Enjoying higher quality audio and video

Enjoying heavy bass with the speakers (H.Bass) **DVD-V** **DVD-VR**

1 2



- ① Press [▲▼] to select "Other Settings".
- ② Press [▶] then [▲▼] to select "Audio Menu".
- ③ Press [▶] then [▲▼] to select "H.Bass".
- ④ Press [▶] then [▲▼] to select "On" or "Off".
- ⑤ Press [ENTER].



Press once.

- This is effective on 5.1 channel DVD-Video and DVD-VR discs. This is also effective on some portions of 2 channel discs as well.
- If the sound is distorted or there is noise, set to "Off".
- To exit the screen: Press [RETURN].

Providing the suitable picture quality for enjoying movies (Cinema1/Cinema2)

Cinema1: Mellows images and enhances detail in dark scenes.
Cinema2: Sharpens images and enhances detail in dark scenes.

1 2



- ① Press [▲▼] to select "Other Settings".
- ② Press [▶] then [▲▼] to select "Picture Menu".
- ③ Press [▶] to select "Picture Mode".
- ④ Press [▶] then [▲▼] to select "Cinema1" or "Cinema2".



Press once.

- ⑤ Press [ENTER].
- To exit the screen: Press [RETURN].

Reducing noise in pictures (Depth Enhancer/MPEG DNR)

Depth Enhancer: Reduces the rough noise in the background to give a greater feeling of depth.
MPEG DNR: Smooths block noise and reduces the smudging that appears around contrasting sections of the picture.

1 2



- ① In the procedure 2—④ (→ above, Cinema1/Cinema2), select "User" and press [ENTER].
 - ② Press [▲▼] to select "Picture Adjustment" and press [ENTER].
 - ③ Press [▲▼] to select "Depth Enhancer" or "MPEG DNR".
 - ④ Press [◀▶] to change the setting.
(Depth Enhancer: 0 to +4, MPEG DNR: 0 to +3)
- To exit the screen: Press [RETURN].



The above indicated features may not work depending on the disc's recording.

Playing audio (WMA/MP3), picture (JPEG) and video (MPEG4/DivX) discs

WMA MP3 JPEG MPEG4 DivX

Select "Play as Data Disc" (→ page 23, Other Menu) in the following cases:

- To play HighMAT discs without using the HighMAT function
- To play audio (**MP3**), picture (**JPEG**) or video (**MPEG4 DivX**) on DVD-RAM with recorded titles (**DVD-VR**)
- To return to playing titles (**DVD-VR**), select "Play as DVD-VR" in "Other Menu" (→ page 23).

Playing items in order (Playback Menu)

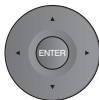

While the menu is displayed
Press [▲▼] to select "All", "Audio", "Picture" or "Video" and press [ENTER].
 • To display/exit the screen:
 Press [TOP MENU].

Playback Menu	
All content	-All Total 438
WMA/MP3	-Audio Total 9
JPEG	-Picture Total 427
MPEG4 and DivX video	-Video Total 2

▲▼ to select and press [ENTER]

Playing from the selected item (Navigation Menu)

1



Press once.

2

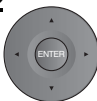

Press [▲▼◀▶] to select the group and press [ENTER].

- To play content in the group in order: Press [ENTER].
- To start play from the selected content: Press [▲▼] to select and press [ENTER].

Group and content number currently playing

Navigation Menu
 002 My favorite 009 Japanese 101 Lady Starfish

Play	Group	Content
▶	002 My favorite	001 My favorite
▶	002 My favorite	002 My favorite
▶	002 Chinese	000 Chinese
▶	002 Czech	000 Czech
▶	002 Hungarian	000 Hungarian
▶	002 Mexican	000 Mexican
▶	002 Philippine	000 Philippine
▶	002 Swedish	000 Swedish
▶	002 Piano	000 Piano
▶	010 None	000 None

Group: 002 Content: 001/000

▶: JPEG
 🎵: WMA/MP3
 📺: MPEG4 and DivX video

Number currently selected

- To listen to WMA/MP3 while showing a JPEG image on the screen: Select a JPEG file first, and then select WMA/MP3. (The opposite order is not effective.)
- To exit the screen: Press [MENU].

Using the submenu

While the navigation menu (→ see above) is displayed.

- 1 Press [DISPLAY].
- 2 Press [▲▼] to select the sub menu and press [ENTER].

Submenu

✓ Multi	Groups and content
List	Content only
Tree	Groups only
Thumbnail	Thumbnail images JPEG
Next group	To the next group
Previous group	To the previous group
✓ All	All content
Audio	WMA/MP3 only
Picture	JPEG only
Video	MPEG4 and DivX video only
✓ Help display	To switch between guide messages and the playback condition indicator
Find	To search by content or group title (→ see below)

Searching by a content or group title

Press [◀▶] to highlight a group title to search a group, or a content title to search its content.

- 1 Select "Find" and press [ENTER]. (→ see above)
- 2 Press [▲▼] to select a character and press [ENTER].



- Repeat to enter another character.
- Lower case is also searched.
- Press and hold [◀▶] to skip between A, E, I, O and U.
- Press [◀] to erase a character.
- Erase the asterisk (*) to search for titles starting with that character.

- 3 Press [▶] to select "Find" and press [ENTER]. The search result screen appears.
- 4 Press [▲▼] to select the content or group and press [ENTER].

Playing HighMAT™ discs WMA MP3 JPEG

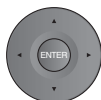

While the menu is displayed
Press [▲▼◀▶] to select items and press [ENTER].



Menu:
 Takes you to the next menu which shows playlists or another menu.



Playlist:
 Play starts.

- To return to the menu screen, press [TOP MENU] then press [RETURN] several times.
- To change the menu background, press [DISPLAY]. The background changes to the one recorded on the disc.
- To display/exit the screen: press [TOP MENU].

Selecting from the list

1. Press [MENU].
 2. Press [◀] then [▲▼] to switch among "Playlist", "Group" and "Content" lists.
 3. Press [▶] then [▲▼] to select an item and press [ENTER].
- To exit the screen : Press [MENU].

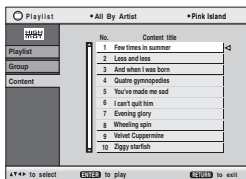

Playing programs/playlists DVD-VR

- Titles appear only if they have been entered.
- You cannot edit playlists and titles.

1 To play programs:

To play playlists:

2

TOP MENU

MENU

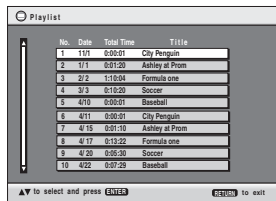
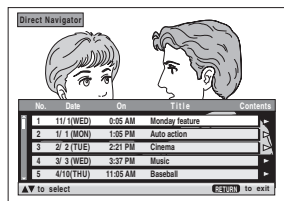

Press [▲▼] to select the program or playlist and press [ENTER].

- Only when the disc contains a playlist.

- Press [▶] to show the contents of the program (Only when playing the program).
- To exit the screen : Press [RETURN].

Playing CD using menus CD

Titles appear with CD text playback.

1 e.g. CD text

2

MENU

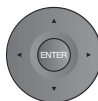
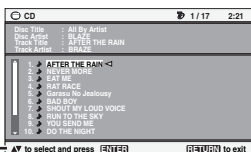

Press [▲▼] to select the tracks and press [ENTER].

- To exit the screen : Press [RETURN].

Press [DISPLAY] to switch between guide messages and the playback condition indicator.

Enjoying in a car

Connecting the included Car DC Adaptor

Before connection, consult your car owner's manual or your dealer.

- Connect to the cigarette lighter socket of a vehicle that has a 12 V battery. It is not compatible with a vehicle that has a 24 V battery.
- This is a special negative grounded Car DC Adaptor. Using this Car DC Adaptor with a plus grounded car can cause malfunction and lead to fire.

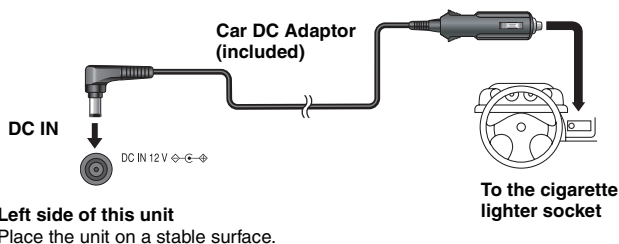

Replacing the fuse

Replace only with the specified 125 V/250 V, 2.5 A fuse. Use of any other type can cause fire.

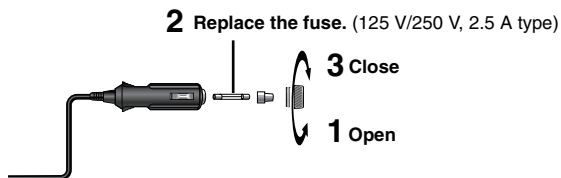

Cautions

- **To avoid draining your car battery**
 - Disconnect the Car DC Adaptor from the cigarette lighter after use. The Car DC Adaptor continues to consume some power even if it is not being used, and if a battery pack is attached to this unit, it will start recharging which uses more power.
 - Do not use the Car DC Adaptor for long periods when the engine is not running.
- Turn the unit off before stopping the engine while using Car DC Adaptor, otherwise resume play (→ page 11) may not work.
- Leave some slack in the cord.
- No responsibility will be taken for damage that occurs due to faulty installation.



(Left side of this unit)

You can enjoy audio through your car audio system by connecting a car stereo cassette adaptor (not included) to the headphone jack on the left side of this unit.

About DivX VOD content

DivX Video-on-Demand (VOD) content is encrypted for copyright protection. In order to play DivX VOD content on this unit, you first need to register the unit.

Follow the on line instructions for purchasing DivX VOD content to enter the unit's registration code and register the unit. For more information about DivX VOD, visit www.divx.com/vod.

Display the unit's registration code

(→ page 25, "DivX Registration" in "Others" tab)



8 alphanumeric characters

- We recommend that you make a note of this code for future reference.
- After playing DivX VOD content for the first time, another registration code is then displayed in "DivX Registration". Do not use this registration code to purchase DivX VOD content. If you use this code to purchase DivX VOD content, and then play the content on this unit, you will no longer be able to play any content that you purchased using the previous code.
- If you purchase DivX VOD content using a registration code different from this unit's code, you will not be able to play this content. ("Authorization Error" is displayed.)

Regarding DivX content that can only be played a set number of times

Some DivX VOD content can only be played a set number of times. When you play this content, the remaining number of plays is displayed. You cannot play this content when the number of remaining plays is zero. ("Rental Expired" is displayed.)

When playing this content

- The number of remaining plays is reduced by one if
 - you turn off the unit or display "Setup" menu.
 - you press [■]. (Press [||] to stop play.)
 - you press [◀▶] (Skip or search) etc. and arrive at another content or the start of the content being played.
- Resume play (→ page 11, Stop) does not work.

Using On-Screen Menus

1



Press once.

2

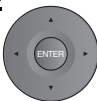

① Press [**▲▼**] to select the menu.

② Press [**▶**] to go to the next menu and [**▲▼**] to set.
Repeat step ② if necessary.

- Items shown differ depending on the type of software.
- Press [**◀**] to go to the previous menu.
- If the setting does not change, press [**ENTER**].
- To exit the screen: Press [**RETURN**].

Main menus

Program, Group, Title Chapter, Track, Playlist Content	To start from a specific item <ul style="list-style-type: none"> • Press [▲▼] to select and press [ENTER]. • Press and hold [▲▼] to alter faster.
Time	To skip incrementally or decrementally (Time Slip for play only) (Except +R/+RW) 1. Press [ENTER] twice to show Time Slip indicator. 2. Press [▲▼] to select the time and press [ENTER]. • Press and hold [▲▼] to alter faster. To change remaining/elapsed time display
Video	To display pixel number [DivX] fps (frame per second) is also displayed.]
Audio	(→ page 14, Changing soundtracks) To display the current bitrate or sampling frequency
Number Select [VCD] (with playback control)	To enter number <ul style="list-style-type: none"> • Press and hold [▲▼] to alter faster.
Thumbnail	To show thumbnail images
Subtitle	(→ page 14, Changing subtitles)
Marker (VR)	To recall a marker recorded on DVD recorders
Angle	(→ page 14, Angle select)
Rotate Picture	(→ page 14, Still picture rotation)
Slideshow	To turn on/off slideshow To change the slideshow timing ("1 Fast" to "5 Slow") <ul style="list-style-type: none"> • When using Slideshow, Skip/Rotate picture may not work correctly depending on the play position.
Other Settings	(→ See below)

Other Settings

Play Speed	(→ page 13, Changing play speed)
-------------------	----------------------------------

Play Menu (Only when the elapsed play time can be displayed,

JPEG: The Repeat function can be used.)

Repeat	(→ page 12, Repeat play)
A-B Repeat	(→ page 12)
Advanced Disc Review	(→ page 13)

Picture Menu

Picture Mode	(→ page 15, Cinema1/Cinema2/Depth Enhancer/MPEG DNR)
Source Select [DivX]	When you select "Auto" the constructing method of the DivX contents is automatically distinguished and output. If the picture is distorted, select "I (Interlace)" or "P (Progressive)" depending on which constructing method was used when the contents were recorded to disc. Auto I (Interlace) P (Progressive)

Audio Menu

H.Bass	(→ page 15)
Advanced Surround	(→ page 13)
Dialogue Enhancer	To make the dialogue in movies easier to hear DVD-VR DVD-V (Dolby Digital, DTS, 3-channel or over, with the dialogue recorded in the center channel) DivX (Dolby Digital, 3-channel or over, with the dialogue recorded in the center channel) On ← → Off
Sound Enhancement	You can enjoy comfortable, analog-like sound. DVD-VR DVD-V (recorded with 48 kHz only) VCD CD WMA MP3 (recorded with other than 8 kHz, 16 kHz or 32 kHz) On ← → Off <ul style="list-style-type: none">• This feature does not work with MP3 on DVD-RAM or DVD-R/RW.• This does not work when H.Bass (→ page 15) or Advanced Surround (→ page 13) is on.• This may not work depending on the disc's recording.

Display Menu

Information	On ← → Off
Subtitle Position	0 to -60 (in 2 units)
Subtitle Brightness	Auto, 0 to -7
Just Fit Zoom	Motion pictures To expand the letterbox picture to fit the screen. Press [▲▼] to select the preset aspect ratio or "Auto". DVD-VR DVD-V VCD Auto ↔ 4:3 Standard ↔ European Vista ↔ 16:9 Standard ↑ ↓ Cinemascope2 ↔ Cinemascope1 ↔ American Vista • Depending on the disc, the preset aspect ratio may not be displayed. MPEG4 DivX Standard ↔ Original ↑ ↔ Full ↔ ↓
Manual Zoom	Motion pictures Press [▲▼] for fine adjustments. (Press and hold to alter faster.) –from ×1.00 to ×1.60 (in 0.01 units) –from ×1.60 to ×2.00 (in 0.02 units) MPEG4 DivX only –from ×2.00 to ×4.00 (in 0.05 units) It may not be possible to zoom up to ×4.00 depending upon the connected television and its settings.
Bit Rate Display	Motion pictures On ← → Off
GUI See-through	Off, On, Auto (Switches on automatically when the images appear on the display.)
Other Menu	
Setup	(→ page 24, Changing the player settings)
Play as DVD-VR Play as HighMAT or Play as Data Disc	Select "Play as Data Disc" in the following cases: –To play HighMAT discs without using the HighMAT function –To play audio (MP3), picture (JPEG) or video (MPEG4 DivX) on DVD-RAM with recorded titles (DVD-VR) <ul style="list-style-type: none">• To return to playing titles (DVD-VR), select "Play as DVD-VR".

Changing the player settings

- Referring to pages 24 to 25, change as required.
- Underlined items are the factory presets.

The settings remain intact even if you switch the unit to standby.

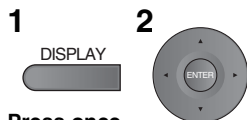

- ① Press [**▲▼**] to select “Other Settings”.
- ② Press [**▶**] then [**▲▼**] to select “Other Menu”.
- ③ Press [**▶**] then [**▲▼**] to select “Setup”.
- ④ Press [**ENTER**].

Press once.

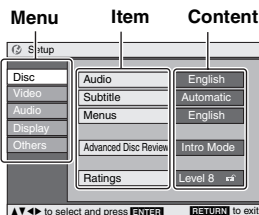

- Press [**▲▼◀▶**] to select the menu, item, content and press [**ENTER**].
- To enter number: press [**▲▼**] to select and Press [**ENTER**].
- To return to the previous screen: Press [**RETURN**].
- To exit the screen: Press [**RETURN**].

“Disc” tab

Audio	<ul style="list-style-type: none"> • <u>English</u> • French • Spanish • Original (The original language designated on the disc is selected) • Other*****
Subtitle	<ul style="list-style-type: none"> • <u>Automatic</u> [If the language selected for “Audio” is not available, subtitles appear in that language (If available on the disc).] • English • French • Spanish • Other*****
Menus	<ul style="list-style-type: none"> • <u>English</u> • French • Spanish • Other*****
Advanced Disc Review Select how to review (→ page 13).	<ul style="list-style-type: none"> • <u>Intro Mode</u>: Reviews each title/program. • Interval Mode: Reviews each 10 minutes.
Ratings Set a ratings level to limit DVD-Video play. • Follow the on-screen instructions.	Setting ratings (When level 8 is selected) <ul style="list-style-type: none"> • <u>8 No Limit</u>. • 1 to 7: To prohibit play of DVD-Video with corresponding ratings recorded on them. • 0 Lock All: To prevent play of discs without ratings levels. When setting a ratings level, a password screen is shown. Follow the on-screen instructions. <p>Do not forget your password. A message screen will be shown if a DVD-Video exceeding the ratings level is inserted in the unit. Follow the on-screen instructions.</p>

※ Input a code number referring to the table on page 25.

“Video” tab

TV Aspect Choose the setting to suit your television and preference.	<ul style="list-style-type: none"> • 4:3 Pan&Scan: Regular aspect television (4:3) The sides of the widescreen picture are cut off so it fills the screen (unless prohibited by the disc). • 4:3 Letterbox: Regular aspect television (4:3) Widescreen picture is shown in the letterbox style. • <u>16:9</u>: Widescreen television Use the television’s screen modes to change the way the picture is shown. 	
Still Mode Specify the type of picture shown when paused.	<ul style="list-style-type: none"> • <u>Automatic</u> • Field: The picture is not blurred, but picture quality is lower. • Frame: Overall quality is high, but the picture may appear blurred. 	

“Audio” tab

Dynamic Range Off

Changing

Using this unit with other equipment

Turn off all equipment before connecting and read the appropriate operating instructions.

Enjoying stereo audio

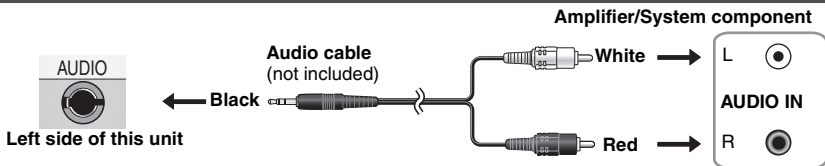

Enjoying with a television

Connect the video output from this unit directly to the television.

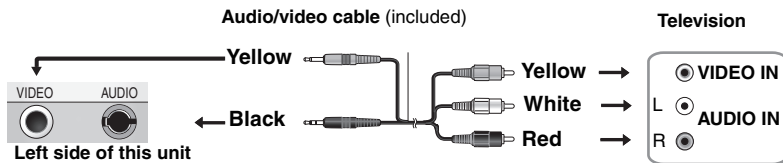

- The unit's speakers do not have magnetic shielding. Do not place the unit near televisions, personal computers or other devices easily influenced by magnetism. Do not keep this unit and magnetized cards (bank cards, commuter passes, etc.) close together.
- If you raise the volume on the television while playing this unit, the volume may abruptly become very loud when you switch to a television broadcast. Return the volume to its normal level before changing.

Watching video from other equipment

1 Connect the equipment to this unit.

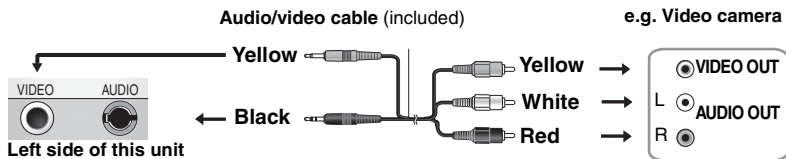

2 Press [AV SELECT] to switch to "AUX" .

"AUX" lights on the unit's display.

- Operate playback using the connected equipment. (Please read the operating instructions for the connected equipment)
- The unit does not turn off automatically while "AUX" mode is on. Turn the unit off when you have finished using it.

Frequently asked questions

Reference pages are shown in parentheses.

Can I play a DVD-Video bought in another country?	You can play if the region number includes "1" or "ALL" and the video standard is NTSC. Check the disc jacket.
Can I use on an airplane or in a hospital?	Electromagnetic waves that are emitted from this unit may affect equipment on an airplane or in a hospital. Please obey the rules and/or instructions indicated by the hospital or airline.
Can I use in a car?	You can use this unit by connecting with the included Car DC Adaptor for power. Damage may occur if you do not use the specified car adaptor. (20)
Can I connect with a computer?	You can enjoy use of the computer as a television monitor when connecting with the AV input terminal on a computer. However, you cannot operate this unit as peripheral equipment.

Maintenance

To clean this unit, wipe with a soft, dry cloth.

- Use eyeglass cleaner to remove stubborn dirt from the LCD.
- Never use alcohol, paint thinner or benzine to clean this unit.

Maintenance of the lens

- Remove dust carefully with an air blower for camera lenses (optional).
- Recommended product:

Lens cleaner kit (SZZP1038C)

(Available from Panasonic dealers.)

- You cannot use a CD type lens cleaner.
- Be careful not to touch the lens with your fingers.

To clean discs

- Wipe with a damp cloth and then wipe dry.

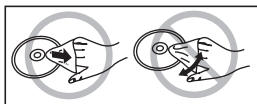

Disc handling precautions

- Do not attach labels or stickers to discs (This may cause disc warping, rendering it unusable).
- Do not write on the label side with a ball-point pen or other writing instrument.
- Do not use record cleaning sprays, benzine, thinner, static electricity prevention liquids or any other solvent.
- Do not use scratch-proof protectors or covers.
- Do not drop stack, or impact discs. Do not place objects on them.
- To protect discs from scratches and dirt, return them to their cases or cartridges when you are not using them.
- Do not use the following discs:
 - Discs with exposed adhesive from removed stickers or labels (rented discs etc).
 - Discs that are badly warped or cracked.
 - Irregularly shaped discs, such as heart shapes.

User memo:

DATE OF PURCHASE _____
DEALER NAME _____
DEALER ADDRESS _____

TELEPHONE NUMBER _____

The model number and serial number of this product can be found on either the back or the bottom of the unit.

Please note them in the space provided below and keep for future reference.

MODEL NUMBER _____

SERIAL NUMBER _____

Specifications

Operating temperature range:
+5 to +35 °C (+41 to +95 °F)

Operating humidity range:
5 to 85 % RH (no condensation)

Discs played [8 cm (3 ") or 12 cm (5 ")]:

- (1) DVD (DVD-Video, DivX^{®6,8})
- (2) DVD-RAM (DVD-VR^{®9}, JPEG^{®4,6,7}, MP3^{®2,6}, MPEG4^{®5,6}, DivX^{®6,8})
- (3) DVD-R (DVD-Video, DVD-VR^{®9}, JPEG^{®4,6,7}, MP3^{®2,6}, MPEG4^{®5,6}, DivX^{®6,8})
- (4) DVD-R DL (DVD-Video, DVD-VR^{®9})
- (5) DVD-RW (DVD-Video, DVD-VR^{®9}, JPEG^{®4,6,7}, MP3^{®2,6}, MPEG4^{®5,6}, DivX^{®6,8})
- (6) +R/RW (Video)
- (7) +R DL (Video)
- (8) CD, CD-R/RW [CD-DA, Video-CD, SVCD^{®1}, MP3^{®2,6}, WMA^{®3,6}, JPEG^{®4,6,7}, MPEG4^{®5,6}, DivX^{®6,8}, HighMAT Level 2 (Audio and Image)]

Signal system: NTSC

LCD screen: 8.5" α -Si, TFT wide-screen LCD

Composite-video output/input:

- Output/input level: 1 Vp-p (75 Ω)
Output/input terminal:
 ϕ 3.5 mm (1/8") mini jack
Number of terminals: 1 system
(output/input selectable)

Audio output/input:

- Output/input level: 1.5 Vrms (1 kHz, 0 dB, 10 k Ω)
Output/input terminal:
 ϕ 3.5 mm (1/8") stereo mini jack
Number of terminals: 1 system
(output/input selectable)

Audio performance:

- (1) Frequency response:
 - DVD (linear audio):
4 Hz to 22 kHz (48 kHz sampling)
4 Hz to 44 kHz (96 kHz sampling)
 - CD audio: 4 Hz to 20 kHz
- (2) S/N ratio:
 - CD audio: 115 dB
- (3) Dynamic range:
 - DVD (linear audio): 91 dB
 - CD audio: 92 dB
- (4) Total harmonic distortion:
 - CD audio: 0.01 %

Headphone output:

- Output: ϕ 3.5 mm (1/8") stereo mini jack
Number of terminals: 2 systems

Pickup:

- Wave length: 662 nm/785 nm (DVD/CD)
Laser power:
(For U.S.A.) CLASS II/CLASS I (DVD/CD)
(For Canada) CLASS 1M/CLASS 1M (DVD/CD)

Power supply: DC 12 V (DC IN terminal)/
DC 7.2 V (Exclusive battery terminal)

Power consumption (using included AC adaptor):
14 W (Unit only: 12 W)

Power consumption in Standby mode
(using included AC adaptor):

approx. 0.4 W

Power consumption in Recharge mode
(using included AC adaptor):

12 W

AC adaptor:

Power source: AC 100 to 240 V, 50/60 Hz

Power consumption: 22 W

DC output: 12 V, 1.3 A

Car DC Adaptor:

DC output: 12 V, 1.5 A

(Vehicle with 12 V battery only)

Battery pack (lithium ion)

DVD-LS80 **DVD-LS850** **CGR-H711** (included):

Voltage: 7.2 V

Capacity: 2250 mAh

DVD-LS82 **CGR-H712** (included):

Voltage: 7.2 V

Capacity: 4500 mAh

Dimensions (W×D×H)

(excluding protrusions and battery):

242.6 mm×173.5 mm×46.0×

Troubleshooting guide

Before requesting service, make the following checks. If you are in doubt about some of the check points, or if the solutions indicated in the chart do not solve the problem, refer to "Customer Services Directory" on page 33 if you reside in the U.S.A., or refer to "Product information" on page 33 if you reside in Canada. In other areas, consult your dealer for instructions. (Reference pages are shown in parentheses.)

The following do not indicate malfunction.

- Sound from the AC adaptor during recharging.
- The battery pack warming up when recharging or during use.
- The surface and area around the unit becoming warm when used for long periods.

Power

No power.

- Check connections to the AC adaptor or battery pack. (8)
- The unit has protection circuitry that is activated if it becomes too hot or too cold. The unit will not work if this occurs. Use the unit between 5 °C (41 °F) and 35 °C (95 °F).

Unit turns off automatically.

- The unit turns off after it has been stopped for about 15 minutes (5 minutes when the unit is powered by the battery pack) to conserve power. Turn the unit on again.

Cannot charge or the [CHG] indicator fails to light.

- The charging time increases when the temperature is too hot or too cold, and charging may not be possible under some circumstances.
- Check connections to the AC adaptor or battery pack. (8)

Play time dramatically reduced after recharging.

- The battery pack has reached the end of its service life (It can be recharged about 300 times).

No operation

No response when any buttons pressed.

- This unit cannot play discs other than the ones listed in these operating instructions. (6)
- The unit may not be operating properly due to lightning, static electricity or some other external factor. Turn the unit off and then back to ON. Alternatively, turn the unit off, disconnect the power source (AC or battery pack), and then reconnect it.
- Condensation has formed: Wait 1 to 2 hours for it to evaporate.
- Please insert the disc correctly. (10)

You have forgotten your ratings password.

- While stopped, press and hold [◀◀] and [||] on the unit and then also press and hold [▶, ON] on the unit until "Initialized" disappears from the screen. Turn the unit off and on again. All settings will return to the default values.

No picture or sound.

- Check that the disc has something recorded on it.

It takes time before play starts.

- Play may take time to begin when an MP3 track has still picture data. Even after the track starts, the correct play time will not be displayed; however, this is normal.
- This is normal on DivX video.

Menu doesn't appear. VCD with playback control

- Press [■, - OFF] twice and then press [▶, ON].

Subtitle position is wrong.

- Adjust the position. ("Subtitle Position" in Display Menu) (23)

No subtitles.

- Display the subtitles. (14)

The subtitles overlap closed captions recorded on discs.



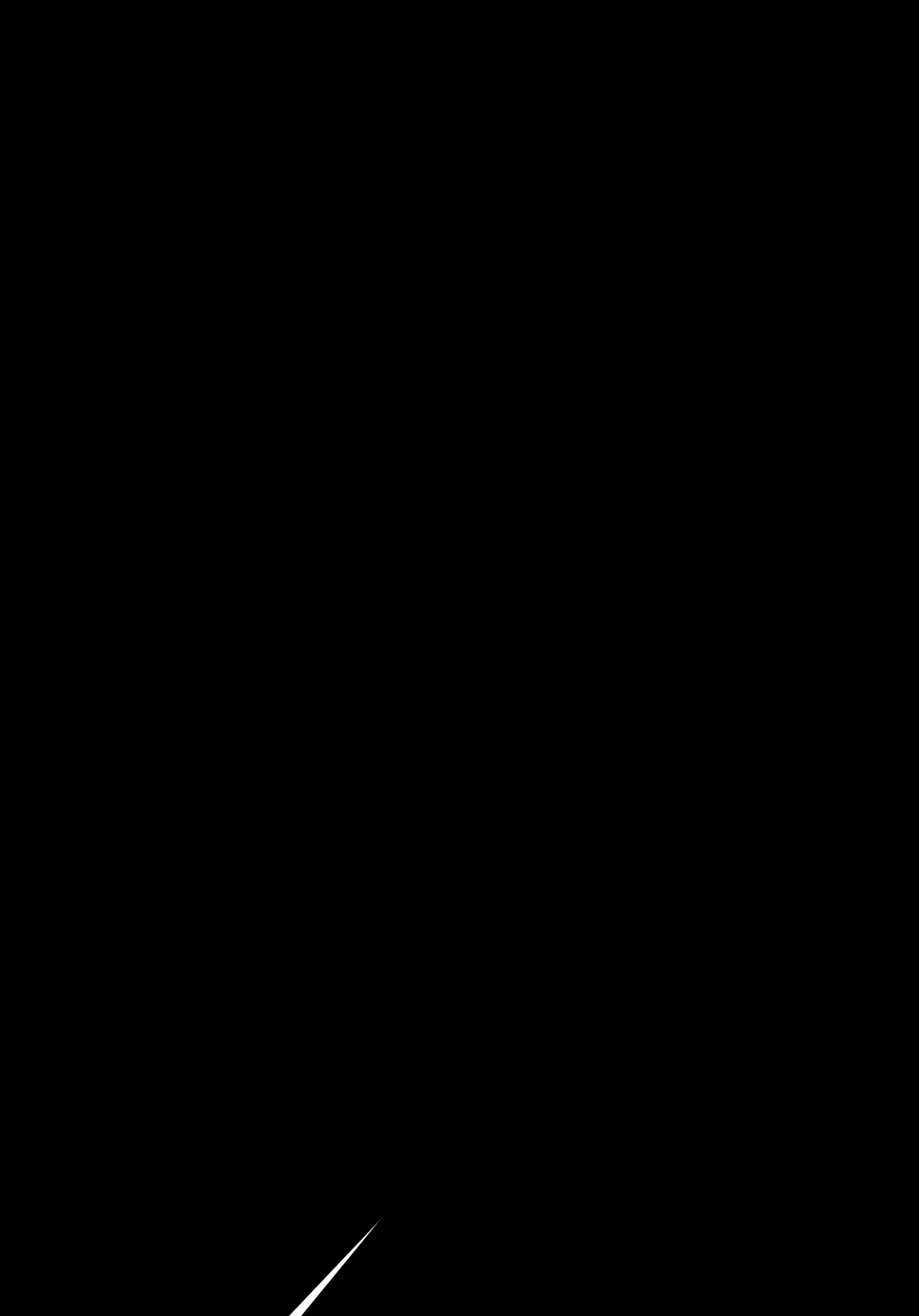

- Clear the subtitles. (14)

In A-B repeat, point B is automatically set.



- If you have set only the starting point (point A), the end of an item becomes point B when it is reached.



Displays

“  ”	<ul style="list-style-type: none"> The operation is prohibited by the unit or disc.
No On-Screen display.	<ul style="list-style-type: none"> Select “On” for “On-Screen Messages” in “Display” tab. (25)
“Check the disc.”	<ul style="list-style-type: none"> Clean the disc. (27)
“U11”	<ul style="list-style-type: none"> You inserted a disc that has not been finalized. (6)
“  ERROR 01”	<ul style="list-style-type: none"> A problem has occurred with the battery pack. Consult your dealer.
“  ERROR 02”	<ul style="list-style-type: none"> The battery pack has been recharging for 20 hours but has failed to recharge for some reason. Recharge again.
“  ERROR 03”	<ul style="list-style-type: none"> You are recharging in a location that is too hot or too cold. Recharge at normal temperature [+5 to +35 °C (+41 to +95 °F)].
“H <input type="checkbox"/> <input type="checkbox"/> ” <input type="checkbox"/> <input type="checkbox"/> stands for a number.	<ul style="list-style-type: none"> Trouble has occurred. The number appearing after “H” depends on the problem. Turn the unit off and on again. Alternatively, turn the unit off, disconnect the power source (AC or battery pack), reconnect the power and turn the unit on again. If the service numbers fail to clear, note the service numbers and consult your dealer.
“Cannot display group xx, content xx”	<ul style="list-style-type: none"> You are trying to play incompatible groups or content. (7)
“Authorization Error”	<ul style="list-style-type: none"> You are trying to play the DivX VOD content that was purchased with a different registration code. You cannot play the content on this unit. (21)
“Rental Expired”	<ul style="list-style-type: none"> The DivX VOD content has zero remaining plays. You cannot play it. (21)

[] and [CHG] indicators

The [] indicator flashes rapidly.	<ul style="list-style-type: none"> The unit has malfunctioned. Consult your dealer.
The [] indicator flashes slowly.	<ul style="list-style-type: none"> The unit is on and the LCD is closed or the LCD-SIZE is set to “MONITOR OFF” (No picture). Turn the unit off when you have finished.
The [CHG] indicator flashes rapidly.	<ul style="list-style-type: none"> There is a problem with the battery pack. Turn the unit on and check the message on the LCD. (above)
The [CHG] indicator flashes slowly.	<ul style="list-style-type: none"> Battery pack charge is low. The unit will turn off automatically after a few minutes.

Limited Warranty (ONLY FOR U.S.A.)

Panasonic Consumer Electronics Company,
Division of Panasonic Corporation of North
America

One Panasonic Way Secaucus,
New Jersey 07094

Panasonic Puerto Rico, Inc.

Ave. 65 de Infantería, Km. 9.5
San Gabriel Industrial Park, Carolina,
Puerto Rico 00985

Panasonic DVD Player Limited Warranty

Limited Warranty Coverage

If your product does not work properly because of a defect in materials or workmanship, Panasonic Consumer Electronics Company or Panasonic Puerto Rico, Inc. (collectively referred to as "the warrantor") will, for the length of the period

indicated on the chart below, which starts with the date of original purchase ("Limited Warranty period"), at its option either (a) repair your product with new or refurbished parts, or (b) replace it with a new or a refurbished product. The decision to repair or replace will be made by the warrantor.

Product or Part Name	Parts	Labor
DVD Player	One (1) Year	Ninety (90) Days
Rechargeable Batteries (in exchange for defective item)	Ten (10) Days	Not Applicable
Headrest mounting bracket, Headphones, Accessories (in exchange for defective item)	Ninety (90) Days	Not Applicable

During the "Labor" Limited Warranty period there will be no charge for labor. During the "Parts" warranty period, there will be no charge for parts. You must mail-in your product during the warranty period. If non-rechargeable batteries are included, they are not warranted. This Limited Warranty only applies to products purchased and serviced in the United States or Puerto Rico. This Limited Warranty is extended only to the original purchaser and only covers product purchased as new. A purchase receipt or other proof of original purchase date is required for Limited Warranty service.

Mail-In Service

For assistance in the continental U.S.A. in obtaining repairs please ship the product to:

**Panasonic Services Company
Customer Servicenter
Suite B
4900 George McVay Drive
McAllen, TX 78503**

For assistance in Puerto Rico call Panasonic Puerto Rico, Inc. (787)-750-4300 or fax (787)-768-2910.

When shipping the unit carefully pack and send it prepaid, adequately insured and preferably in the original carton. Include a letter detailing the complaint and provide a day time phone and/or email address where you can be reached.

IF REPAIR IS NEEDED DURING THE LIMITED WARRANTY PERIOD THE PURCHASER WILL BE REQUIRED TO FURNISH A SALES RECEIPT/PROOF OF PURCHASE INDICATING DATE OF PURCHASE, AMOUNT PAID AND PLACE OF PURCHASE. CUSTOMER WILL BE CHARGED FOR THE REPAIR OF ANY UNIT RECEIVED WITHOUT SUCH PROOF OF PURCHASE.

Limited Warranty Limits And Exclusions

This Limited Warranty ONLY COVERS failures due to defects in materials or workmanship, and DOES NOT COVER normal wear and tear or cosmetic damage. The Limited Warranty ALSO DOES NOT COVER damages which occurred in shipment, or failures which are caused by products not supplied by the warrantor, or failures which result from accidents, misuse, abuse, neglect, mishandling, misapplication, alteration, faulty installation, set-up adjustments, misadjustment of consumer controls, improper maintenance, power line surge, lightning damage, modification, or commercial use (such as hotel, office, restaurant, or other business), rental use of the product, or service by anyone other than a Factory Servicenter or other Authorized Servicer, or damage that is attributable to acts of God.

THERE ARE NO EXPRESS WARRANTIES EXCEPT AS LISTED UNDER "LIMITED WARRANTY COVERAGE". THE WARRANTOR IS NOT LIABLE FOR INCIDENTAL OR CONSEQUENTIAL DAMAGES RESULTING FROM THE USE OF THIS PRODUCT, OR ARISING OUT OF ANY BREACH OF THIS WARRANTY. (As examples, this excludes damages for lost time, cost of having someone remove or re-install an installed unit if applicable, travel to and from the servicer, loss of or damage to media or images, data or other recorded content. The items listed are not exclusive, but are for illustration only.) ALL EXPRESS AND IMPLIED WARRANTIES, INCLUDING THE WARRANTY OF MERCHANTABILITY, ARE LIMITED TO THE PERIOD OF THE LIMITED WARRANTY.

Some states do not allow the exclusion or limitation of incidental or consequential damages, or limitations on how long an implied Limited Warranty lasts, so the exclusions may not apply to you.

This Limited Warranty gives you specific legal rights and you may also have other rights which vary from state to state. If a problem with this product develops during or after the Limited Warranty period, you may contact your dealer or Servicenter. If the problem is not handled to your satisfaction, then write to the warrantor's Consumer Affairs Department at the addresses listed for the warrantor. **PARTS AND SERVICE, WHICH ARE NOT COVERED BY THIS LIMITED WARRANTY, ARE YOUR RESPONSIBILITY.**

Customer Services Directory

Obtain Product Information and Operating Assistance; locate your nearest Dealer or Servicenter; purchase Parts and Accessories; or make Customer Service and Literature requests by visiting our Web Site at:

<http://www.panasonic.com/consumersupport>

or, contact us via the web at:

<http://www.panasonic.com/contactinfo>

You may also contact us directly at:

1-800-211-PANA (7262),

Monday-Friday 9 am-9 pm; Saturday-Sunday 10 am-7 pm, EST.

For hearing or speech impaired TTY users, TTY: 1-877-833-8855

Accessory Purchases

Purchase Parts, Accessories and Instruction Books online for all Panasonic Products by visiting our Web Site at:

<http://www.pstc.panasonic.com>

or, send your request by E-mail to:

npcparts@us.panasonic.com

You may also contact us directly at:

1-800-332-5368 (Phone) 1-800-237-9080 (Fax Only) (Monday – Friday 9 am to 8 pm, EST.)

Panasonic Service and Technology Company

20421 84th Avenue South, Kent, WA 98032

(We Accept Visa, MasterCard, Discover Card, American Express, and Personal Checks)

For hearing or speech impaired TTY users, TTY : 1-866-605-1277

Service in Puerto Rico

Panasonic Puerto Rico, Inc.

Ave. 65 de Infantería, Km. 9.5, San Gabriel Industrial Park, Carolina, Puerto Rico 00985

Phone (787)750-4300, Fax (787)768-2910

F1104

Product Service

- Damage requiring service**—The unit should be serviced by qualified service personnel if:
 - The AC power supply cord or AC adaptor has been damaged; or
 - Objects or liquids have gotten into the unit; or
 - The unit has been exposed to rain; or
 - The unit does not operate normally or exhibits a marked change in performance; or
 - The unit has been dropped or the cabinet damaged.
- Servicing**—Do not attempt to service the unit beyond that described in these operating instructions. Refer all other servicing to authorized servicing personnel.
- Replacement parts**—When parts need replacing ensure the servicer uses parts specified by the manufacturer or parts that have the same characteristics as the original parts. Unauthorized substitutes may result in fire, electric shock, or other hazards.
- Safety check**—After repairs or service, ask the servicer to perform safety checks to confirm that the unit is in proper working condition.

Product information

For product information or assistance with product operation:

In the U.S.A., refer to "Customer Services Directory" above.

In Canada, contact the Panasonic Canada Inc. Customer Care Centre at 1-800-561-5505, or visit the website (www.panasonic.ca), or an authorized Servicentre closest to you.

Limited Warranty (ONLY FOR CANADA)

Panasonic Canada Inc.

PANASONIC PRODUCT – LIMITED WARRANTY

Panasonic Canada Inc. warrants this product to be free from defects in material and workmanship and agrees to remedy any such defect for a period as stated below from the date of original purchase.

Technics Audio Product	One (1) year, parts and labour
Panasonic Portable/Clock Radio (without Tape, CD, MD)	One (1) year, parts and labour
Panasonic Audio/SD Audio Product	One (1) year, parts and labour
Panasonic DVD Product	One (1) year, parts and labour
Panasonic Combination DVD Player/VCR	One (1) year, parts and labour
Panasonic Combination DVD Recorder/VCR	One (1) year, parts and labour
Accessories including rechargeable batteries	Ninety (90) days

LIMITATIONS AND EXCLUSIONS

This warranty does not apply to products purchased outside Canada or to any product which has been improperly installed, subjected to usage for which the product was not designed, misused or abused, damaged during shipping, or which has been altered or repaired in any way that affects the reliability or detracts from the performance, nor does it cover any product which is used commercially. Dry cell batteries are also excluded from coverage under this warranty.

This warranty is extended to the original end user purchaser only. A purchase receipt or other proof of date of original purchase is required before warranty service is performed.

THIS EXPRESS, LIMITED WARRANTY IS IN LIEU OF ALL OTHER WARRANTIES, EXPRESS OR IMPLIED, INCLUDING ANY IMPLIED WARRANTIES OF MERCHANTABILITY AND FITNESS FOR A PARTICULAR PURPOSE.

IN NO EVENT WILL PANASONIC CANADA INC. BE LIABLE FOR ANY SPECIAL, INDIRECT OR CONSEQUENTIAL DAMAGES.

In certain instances, some jurisdictions do not allow the exclusion or limitation of incidental or consequential damages, or the exclusion of implied warranties, so the above limitations and exclusions may not be applicable.

WARRANTY SERVICE

FOR PRODUCT OPERATION ASSISTANCE, please contact:

Our Customer Care Centre:	Telephone #:	(905) 624-5505
	1-800 #:	1-800-561-5505
	Fax #:	(905) 238-2360
	Email link:	"Customer support" on www.panasonic.ca

FOR PRODUCT REPAIRS, please locate your nearest Authorized Servicentre at www.panasonic.ca :

Link : "Servicentres™ locator" under "Customer support"

IF YOU SHIP THE PRODUCT TO A SERVICENTRE

Carefully pack and send prepaid, adequately insured and preferably in the original carton. Include details of the defect claimed, and proof of date of original purchase.

Manufactured under license from Dolby Laboratories. Dolby and the double-D symbol are trademarks of Dolby Laboratories.

"DTS" is a registered trademark of DTS, Inc. and "DTS 2.0" is a trademark of DTS, Inc.

Apparatus Claims of U.S. Patent Nos. 4,631,603, 4,577,216, and 4,819,098, licensed for limited viewing uses only.

This product incorporates copyright protection technology that is protected by method claims of certain U.S. patents and other intellectual property rights owned by Macrovision Corporation and other rights owners. Use of this copyright protection technology must be authorized by Macrovision Corporation, and is intended for home and other limited viewing uses only unless otherwise authorized by Macrovision Corporation. Reverse engineering or disassembly is prohibited.

This product is licensed under the MPEG-4 Visual patent portfolio license for the personal and non-commercial use of a consumer for (i) encoding video in compliance with the MPEG-4 Visual Standard ("MPEG-4 Video") and/or (ii) decoding MPEG-4 Video that was encoded by a consumer engaged in a personal and non-commercial activity and/or was obtained from a video provider licensed by MPEG LA to provide MPEG-4 Video. No license is granted or shall be implied for any other use. Additional information including that relating to promotional, internal and commercial uses and licensing may be obtained from MPEG LA, LLC. See <http://www.mpegla.com>.

HighMAT™ and the HighMAT logo are either trademarks or registered trademarks of Microsoft Corporation in the United States and/or other countries.



Windows Media and the Windows logo are trademarks or registered trademarks of Microsoft Corporation in the United States and/or other countries.

This product is protected by certain intellectual property rights of Microsoft Corporation and third parties. Use or distribution of such technology outside of this product is prohibited without a license from Microsoft or an authorized Microsoft subsidiary and third parties.

WMA is a compression format developed by Microsoft Corporation. It achieves the same sound quality as MP3 with a file size that is smaller than that of MP3.

Official DivX® Certified product.

Plays all versions of DivX® video (including DivX®6) with standard playback of DivX® media files.

DivX, DivX Certified, and associated logos are trademarks of DivX, Inc. and are used under license.



THE FOLLOWING APPLIES ONLY IN THE U.S.A.

Notice:

This product has a fluorescent lamp that contains mercury. Disposal may be regulated in your community due to environmental considerations. For disposal or recycling information, please contact your local authorities, or the Electronic Industries Alliance: <<http://www.eiae.org>>

Index

A	A-B Repeat	12	N	Navigation Menu	16
	Advanced Disc Review	13		Number Select	11, 22
	Advanced Surround	13	O	On-Screen Menus	22
	Angle select	14	P	Play speed	13
	AV SELECT	26		Playback Menu	16
B	BRIGHT-LCD	12		Playlist	17
C	Car DC Adaptor	20		Programs	17
	CD text playback	17	Q	Quick OSD	15
	Cinema1/Cinema2	15	R	Re-initialize Setting	25
D	Depth Enhancer	15		REPEAT	12
	Dialogue Enhancer	23		Resume play	11
	DISPLAY	15, 22, 24		Rotate Picture	14
	DivX	6, 7, 21	S	Setup	24
	Dolby Digital	14		Sound Enhancement	23
	DTS	14		Soundtrack	14
F	Finalize	6		Subtitle	14
H	H.Bass	15	T	Time Slip for play only	22
	Headrest Mounting Bracket	18		TOP MENU	11, 16, 17
	HighMAT	17			
J	Just Fit Zoom	23			
L	LCD-SIZE	12			
M	Manual Zoom	23			
	MENU	11, 16, 17			
	MPEG DNR	15			
	MPEG4	6, 7			



This manual was printed with soy based ink.

**Panasonic Consumer Electronics Company,
Division of Panasonic Corporation of North
America**

One Panasonic Way Secaucus,
New Jersey 07094

<http://www.panasonic.com>

Panasonic Canada Inc.

5770 Ambler Drive, Mississauga, Ontario L4W 2T3
www.panasonic.ca

© 2006 Matsushita Electric Industrial Co., Ltd.
Printed in China

Panasonic Puerto Rico, Inc.
Ave. 65 de Infantería, Km. 9.5
San Gabriel Industrial Park, Carolina,
Puerto Rico 00985

En

RQT8912-4P
F1206BL4047